



Spa Owner's Manual

FOR

PERFORMANCE XS

AND

WHITEWATER XS

NOTE: Important Safety Instructions. Please read and follow all instructions before installing, operating or enjoying your spa.

Please refer to the operational video that is supplied with spa.

Save these instructions for future reference.



A BRIEF HISTORY OF SPAS

During the 5th century B.C., the mineral springs in Greece and the Aegean Islands served as healing clinics. At one particular clinic on the Island of Cos, a Greek physician Hypocrites practiced medicine while writing extensively on hydrotherapy.

In the province of Leige, Belgium mineral springs were favored for centuries by notables and royalty, including Russian Czar Peter the Great and German Kaiser William II. Mineral springs in those days were very similar to today's spas in that both were used for therapeutic and recreation purposes.

The ancient Romans, after a day of conquering the world, retreated to the pleasures of their mineral springs. In fact, many well-preserved mineral springs built by the ancient Romans still exist today in places as far off as Bath, England and Tiberias, Israel. After the fall of the Roman Empire in the 5th century A.D., the number of mineral springs decreased. It was not until the renaissance, mysteriously enough that they again became popular. This raises an interesting question: Does the use of mineral springs or spas result in great thinking, or do great thinkers resort to the use of mineral springs or spas?

Your new PERFORMANCEXS™ or WHITEWATERXS™ is the modern™ machine for today's great thinkers and athletes of any age. The spa blends many advanced features to help you enjoy the complete benefits of heated, moving and filtered water for therapy and relaxation. Baja Products, Ltd. is the originator of the acrylic spa, and has built world class products since 1969. We wish you years of enjoyment and relaxation with your new Baja spa. Please take a few minutes to read the valuable safety instructions and operating features described in this manual.

DIRECTORY

SAFETY INSTRUCTIONS.....	PAGE	2
INSTALLATION GUIDELINES.....	PAGE	4
ELECTRICAL – GENERAL INFORMATION / 240 VOLT INSTALLATION	PAGE	5
GROUND FAULT INTERRUPTER.....	PAGE	6
INITIAL START UP	PAGE	6
EQUIPMENT FEATURES	PAGE	7
SPA CONTROLLER FUNCTIONS.....	PAGE	7
IN-HOUSE CONTROL PANEL (OPTIONAL).....	PAGE	9
EQUIPMENT MODULE	PAGE	9
WINTER & SUMMER PROGRAM MODES	PAGE	10
WARM WEATHER CONDITIONS.....	PAGE	10
INSTALLING YOUR PURIFICATION DISPENSER.....	PAGE	10
JET & FILTER OPERATION.....	PAGE	11
NIGHTSCAPE LED LIGHTING SYSTEM SHOWS.....	PAGE	11
BAJA EXTREME SOUND PRECAUTIONS	PAGE	11
BAJA BREEZE AROMATHERAPY.....	PAGE	12
REGULAR SPA MAINTENANCE	PAGE	12
SPA MAINTENANCE SCHEDULE.....	PAGE	12
CLEANING THE ACRYLIC SURFACE	PAGE	12
SPA CABINET INSTRUCTIONS	PAGE	13
CABINET DRAIN VALVE INSTALLATION.....	PAGE	13
GENERAL TROUBLESHOOTING	PAGE	14
CONTROLLER ERROR INDICATORS.....	PAGE	15

Date _____ Model # _____ Serial Number

SAFETY INSTRUCTIONS

When installing and using this electrical equipment, basic safety precautions should always be followed, including the following:

1. **READ AND FOLLOW ALL INSTRUCTIONS.**
2. **WARNING** - To reduce the risk of injury, do not permit children to use this product unless they are closely supervised at all times.
3. A wire connector is provided on this unit to connect a minimum No. 8 AWG (8.4mm²) solid copper conductor between this unit and any metal equipment, metal enclosures of electrical equipment, metal water pipe, or conduit within 5 feet (1.5m) of the unit.
4. **DANGER - Risk of injury. (For Cord-Connected/Convertible Units.)**
 - a) Replace damaged cord immediately.
 - b) Do not bury cord.
 - c) Connect to a grounded, grounding type receptacle only.
5. The electrical supply for this product must include a suitably rated switch or circuit breaker to open all ungrounded supply conductors to comply with section 422-20 of the National Electrical Code ANSI/NFPA 70. The disconnecting means must be readily accessible to the spa occupant but installed at least 5 feet (1.5m) from spa water.

WARNING - Prevent Electrocuton. Baja BXS Extreme Sound Precautions. Refer to Page 11.

6. **DANGER - Risk of Accidental Drowning.** Extreme caution must be exercised to prevent unauthorized access by children. To avoid accidents, ensure that children cannot use this spa unless they are supervised at all times.
7. **DANGER - Risk of Injury.** The suction fittings in this spa are sized to match the specific water flow created by the pump. Should the need arise to replace the suction fittings or the pump, be sure that the flow rates are compatible.

Never operate spa if the suction fittings are broken or missing. Never replace a suction fitting with one rated less than the flow rate marked on the original suction fitting.
8. **DANGER - Risk of Electric Shock.** Install at least 5 feet (1.5m) from all metal surfaces. As an alternative, a spa may be installed within 5 feet of metal surfaces if each metal surface is permanently connected by a minimum No. 8 AWG (8.4mm²) solid copper conductor to the bonding lugs on the control box that is provided for this purpose.
9. **DANGER - Risk of Electric Shock.** Do not permit any electric appliance, such as a light, telephone, radio, or television, within 5 feet (1.5m) of a spa.
10. Always enter and exit the spa slowly and cautiously. Wet surfaces can be slippery.
11. Do not use the spa alone.
12. People with infections, skin sores or open wounds should not use the spa.
13. It is recommended that people shower before and after using the spa.
14. Disconnect all electrical power before attempting any kind of service to the electrical module.
15. Always use unbreakable containers around the spa. Never use glass.
16. Never walk, climb, play or jump on the insulated cover of your spa. Never use the spa unless the cover has been completely removed. Do not rely on the cover as a safety cover for children. Children must be supervised when they are in or around the spa.
17. A fence around your spa with a self-closing and self-latching gate can be the best protection against unauthorized use. If your spa is indoors, lock the door to the room to keep out unauthorized users.

SAFETY INSTRUCTIONS, CONT'D

18. Install to provide drainage of compartment with electrical components.

19. **WARNING - To reduce the risk of injury:**

- a) The water in a spa should never exceed 40°C (104°F). Water temperature between 38°C (100°F) and 40°C (104°F) are considered safe for a healthy adult. Lower water temperatures are recommended for young children and when spa use exceeds 10 minutes.
- b) Since excessive water temperatures have a high potential for causing fetal damage during the early months of pregnancy, pregnant or possibly pregnant women should limit spa water temperatures to 38°C(100°F).
- c) Before entering a spa, the user should measure the water temperature with an accurate thermometer since the tolerance of water temperature-regulating devices varies.
- d) The use of alcohol, drugs, or medication before or during spa use may lead to unconsciousness with the possibility of drowning.
- e) Persons suffering from obesity or with a medical history of heart disease, low or high blood pressure, circulatory system problems, or diabetes should consult a physician before using a spa.
- f) Persons using medication should consult a physician before using a spa since some medication may induce drowsiness while other medication may affect heart rate, blood pressure, and circulation.
- g) Leave the spa immediately if nausea, dizziness or headaches occur. Immediately cool the body by taking a cool shower or apply cold towels or ice packs. Seek medical attention if the symptoms persist.

20. Hyperthermia occurs when the internal temperature of the body reaches a level several degrees above the normal body temperature of 98.6°F. The symptoms of hyperthermia include an increase in the internal temperature of the body, dizziness, lethargy, drowsiness and fainting.

THE EFFECTS OF HYPERTHERMIA INCLUDE:

- (1) Failure to perceive heat,
- (2) Failure to recognize the need to exit spa,
- (3) Unawareness of impending hazard,
- (4) Fetal damage in pregnant women,
- (5) Physical inability to exit spa,
- (6) Unconsciousness resulting in the danger of drowning.

WARNING - The use of alcohol, drugs, or medication can greatly increase the risk of fatal hyperthermia.

21. Inform all occasional users of these precautions.

22. **SAVE THESE INSTRUCTIONS.**

INSTALLATION GUIDELINES

1. Locate your spa on a solid, level surface that is structurally strong enough to support its filled weight.
2. Installations on wooden decks or balconies should be checked to insure that the floor can support the weight of the full spa and the persons using it.
3. A reinforced poured concrete slab (min. 4" thick) is recommended. However, wood decking is also acceptable, provided it is constructed so that it meets the requirements outlined above.
4. The spa must be installed in such a manner as to provide drainage away from the spa.
5. Spas which will be installed into a floor or wood deck must be installed to permit access to the equipment for servicing.
6. Do not install the spa under any electrical wires.
7. In selecting the ideal outdoor location for your spa, we suggest you take into consideration the following:
 - A) The view you'll have from the spa.
 - B) The proximity to your home for change and/or shelter (this is very important in cold weather).
 - C) A sheltered environment, providing protection from wind and weather if needed.
 - D) The overall enhancement of your yard or room.
 - E) Do not place the spa under a non-guttered roof overhang.
 - F) Indoor installations require provisions for proper ventilation.
 - G) Check local codes for building and fence requirements.
 - H) Water is carried and splashed out by the user, be sure the spa is not located in an area or on a surface that may be damaged by water. (Examples: Carpeting, 2nd floor in house, etc.)
 - I) Indoor spas should be installed in rooms constructed of materials that will not be damaged by high humidity.

ELECTRICAL

GENERAL INFORMATION

All electrical connections must be accomplished by a qualified electrician in accordance with the National Electrical Code and in accordance with any local codes in effect at the time of installation. All electrical connections must be made in accordance with the wiring information in this manual or on the back of the field wiring access panel of the Equipment Module.

Connections must be made using copper conductors only. Field provided conductors, circuit breakers or fuses must be sized to accommodate the total amperage load of the Equipment Module.

WARNING: Improper electrical connections or conductor sizing may cause the Equipment Module to operate improperly, create the potential for an electrical hazard and may void the warranty.

CAUTION: Use only approved pressure type wire splicing or connectors suitable for the size and type of wiring used.

The electrical supply for the product must include a suitably rated switch or circuit breaker to open all ungrounded supply conductors to comply with Section 422-20 of the National Electrical Code ANSI/NFPA 70. The disconnecting means must be within sight and readily accessible to the user of the spa. It must be installed at least 5 feet (1.5M) from the spa.

Connect a NO. 8 AWG (8.4mm) solid copper bonding conductor between the Equipment Module bonding lug and all other electrical equipment and exposed metal in the vicinity as may be needed to comply with local regulations.

A PERMANENTLY CONNECTED SPA is one that is complete with pumps, heater, lighting fixtures and spa side controls.

240 VOLT INSTALLATION

THE FOLLOWING INSTRUCTIONS ARE FOR 240 VOLT - 50 AMPERES APPLICATIONS

The heater will provide 4500 watts (4.5kw) of heat when the circulation pump is on and the thermostat is calling for heat.

The following instructions must be followed for a permanently connected equipment module designed to operate at 240 Volts.

1. Connect input wiring as shown above. When connected to 240 Volts, the equipment module requires a three wire electrical service, plus ground (line 1, line 2, Neutral, Ground), and requires a minimum supply conductor ampacity of 50 Amperes.

2. Close the wiring access panel.

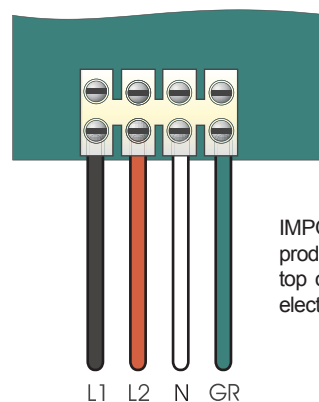

IMPORTANT: Always refer to the product data label (Located on top of Control Box) for specific electrical information.

(Line 1, Line 2, Neutral) #6 AWG Minimum and Ground #10 AWG Minimum.

ELECTRICAL, CONT'D

GROUND FAULT INTERRUPTER

Ground-Fault Circuit-Interrupters and Load Neutral Connection

Most 240 volt panel mounted Ground-Fault Circuit-Interrupter's (GFCI's) are provided with a "LINE" neutral connection lead. Since the GFCI itself is a 120 volt device, this wire must be connected to the neutral buss bar in order for the GFCI to function properly.

Many GFCI's are also provided with a "LOAD" neutral connection terminal. The purpose of the "LOAD" neutral connection terminal is to allow the connection of 120 volt devices to the 240 volt GFCI. If the circuit being connected does not contain any 120 volt devices, the LOAD neutral connection is not used, and the GFCI will provide protection of all 240 volt devices connected. A "LOAD" neutral terminal connection is NOT needed in order for the GFCI to function.

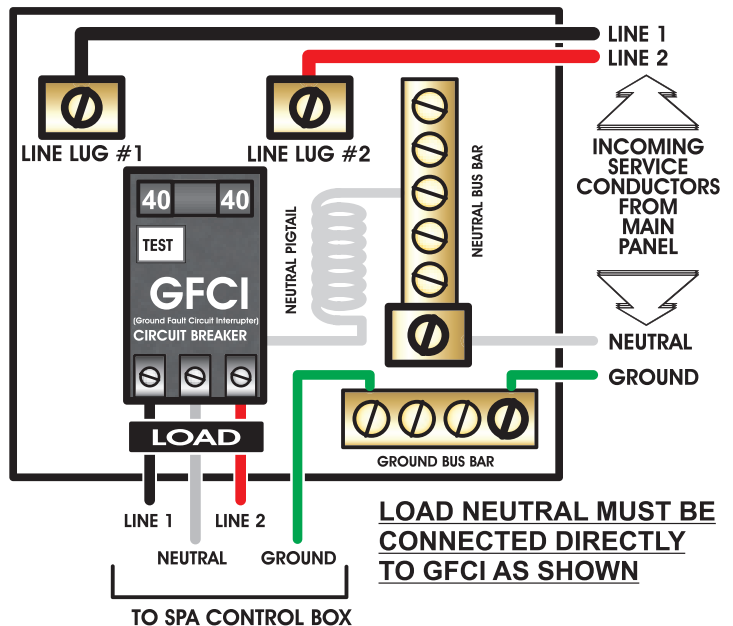

INITIAL STARTUP

WARNING: In order to check for leaks, the following steps are performed without the skirting in place. To prevent risk of electric shock, do not use spa at this time.

1. Make sure the power supply is OFF.
2. Check to see that the Black Drain Valve (located to the left side of Equipment Module) is closed.
3. Fill the spa with water to the center line of the skimmer. Bleed air from the filter and equipment module by opening the air relief plug (located at top of the filter). Tighten plug when finished.

IMPORTANT NOTE: The Equipment Module must never be operated without water in the spa, serious damage to the heater and/or pump could result.

4. The slide valves on each side of the Equipment Module should be open (the valve is open when the handle is pulled out, closed when it is pushed in).

IMPORTANT NOTE: Valves snap lock into place in "open" and "closed" positions.

5. Check all plumbing connections for water leaks. Although spas are fully checked at factory, shipping & delivery might cause a leak. Call your dealer or Baja directly if there is a problem.
6. Before power is applied, refer to and become familiar with the spa side control operations.
7. Apply power to the spa.

IMPORTANT NOTE: Make sure the Power Switch on the Equipment Module is turned on before applying power to the spa.

8. Temperature reading will be displayed on digital control. Increase heat set temperature to desired setting.
9. Circulation Pump System will come on.

EQUIPMENT FEATURES

NOTE: BEFORE FILLING SPA, PLEASE FAMILIARIZE YOURSELF WITH THE FEATURES OF THE EQUIPMENT MODULE & CONTROL

SPA CONTROLLER FUNCTIONS

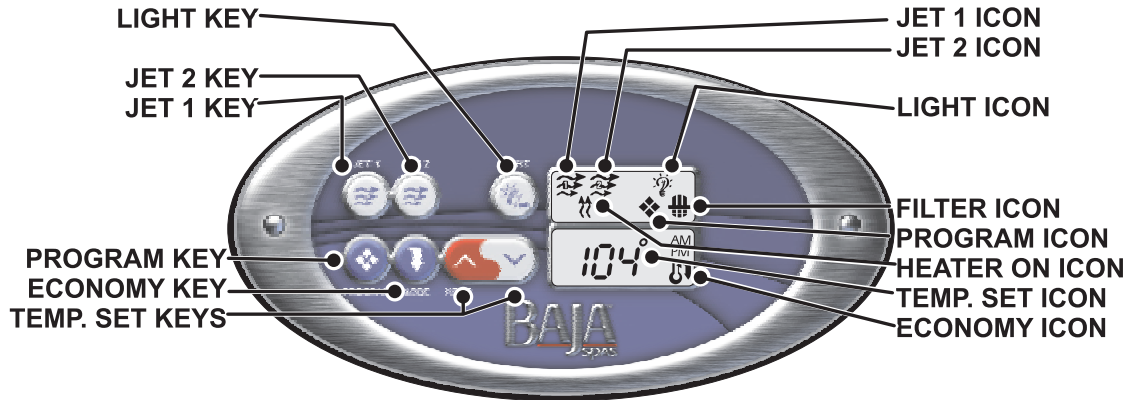

JETS KEYS: Press the Jet 1 or Jet 2 key once to activate the low speed of the desired pump, press the key a second time to activate high speed and pressing it a third time will turn the pump off. After 20-minutes, the pump will shut off automatically unless done so manually. The JETS icon will illuminate while the pump is on in high speed and flash in low speed. If a filter cycle is active, the “filter cycle” indicator will be illuminated (the JETS indicator WILL NOT be on during filtration). (Only WhiteWaterXS has second Jet)

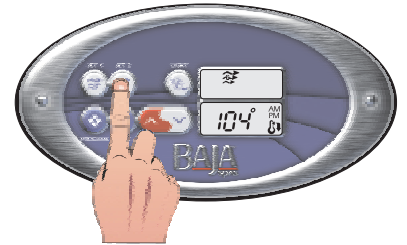

LIGHT/ENTER KEY: Use the spa’s light key to turn NIGHTSCAPE on and off. The Light Icon will appear while the light is on. Lights are preprogrammed with an assortment of light shows. When you press the Light key off and then on again within five seconds, it advances to the next show. When you turn NIGHTSCAPE off and leave it off for more than five seconds, it “remembers” the last show you selected. The next time you turn NIGHTSCAPE on, it will display the last show programmed. (See page 11 for show schedule.) The light will automatically shut off after 2 hours.

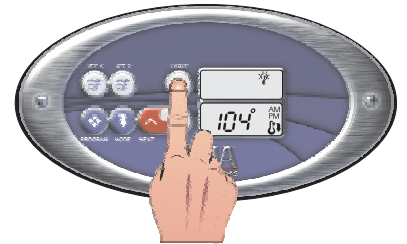

TEMPERATURE SET KEY: Press the up arrow to increase the temperature. Press the down arrow to decrease the temperature. The temperature can be adjusted in 1°F increments from 59°F to 104°F (5°C to 40°C). The new setting will remain on the display for 5 seconds as confirmation. During this time the Temp. Set icon will appear to let you know this is the desired and not the actual temperature. After 5 seconds, the display will return to the current temperature reading. When the temperature drops to 1°F below the set temperature, the heater will be turned on until the temperature is 1°F above the set temperature. The Heater On icon will appear while the heater is on and flash when there is a call for heat and the heater has not yet been activated.

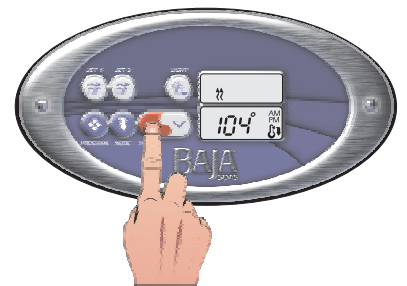

EQUIPMENT FEATURES, CONT'D



PROGRAMMING TIME OF DAY: Press and hold the Program key for 5-seconds, the program icon will appear. (1) The first parameter will appear with the hour flashing. To adjust, (2) press the Enter (Light) key, use the Temp. Set keys to adjust the hour from 01: to 12: am or pm. (3) Press the Program key then Enter (Light) key to adjust minutes, use the Temp. Set keys to adjust the minutes from :00 to :59. Press the Program key to confirm the new setting and wait until controller resets Temperature / Time. Spa will be programmed.

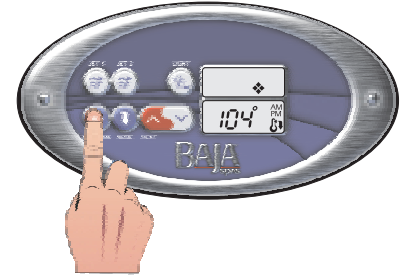
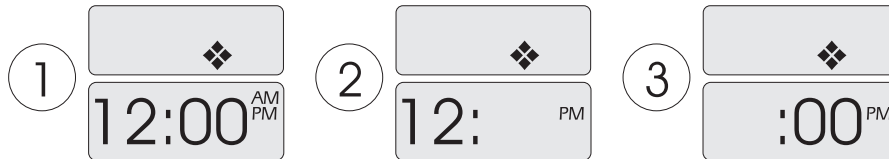

Economy Mode: A user activated feature that can potentially save energy by causing the system to maintain a temperature of 20°F below the user programmed set temperature during peak hours or when the spa is not in use. Pressing this key displays the current Economy setting and allows you to adjust energy saving features built-in to your control. Baja Spas Self-Cleaning Spa Filtration Program has been designed to efficiently circulate 24 hours per day. The circulation pump system will only turn off when the spa temperature exceeds 4 (four) degrees above the actual temperature set point.

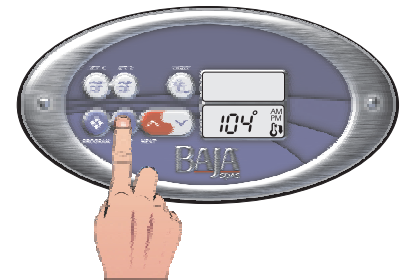

STANDARD/STARTUP MODE: The first press will show "no EC". The system will maintain the spa water to the desired set temperature without restriction 24 hours a day.

* For use at startup, and by the user that wishes to have their spa ready at all times.



VACATION/TRAVEL MODE: A second press will display "EC1". This mode causes Economy mode to be active 24hrs a day.

* For the cost-conscious traveler or when spa is rarely used. Allow several hours for spa to heat when using this mode.



DAYTIME/PEAK HOUR MODE: A third press will display "EC2" and activate the daytime/peak hour mode. Economy mode will be active between the hours of 10:00AM and 6:00PM.

* Use to avoid peak electrical energy costs.



NIGHTTIME MODE: A fourth press will display "EC3" and activate the nighttime mode. Economy mode will be active between the hours 11:00PM to 8:00AM.

* For the user that does not wish to heat their spa during the nighttime hours.



MAX ECONOMY MODE: A fifth press will display "EC4" and activate the Max Economy mode. "Max" economy mode is a combination of EC2 & EC3. Economy mode is active between 10:00AM to 6:00PM and 11:00PM to 8:00AM.

* Use to avoid peak electrical energy cost for both daytime and nighttime.

These settings are manual settings and must be activated and deactivated by pressing the economy key. The settings will be retained in system memory in the event of a power outage. **Baja Recommended: "noEC" mode during normal usage times.**

INVERTED DISPLAY: Lower display can be inverted for easy viewing inside or outside the spa. Press and hold the Mode key for 2 seconds to toggle between inverted and normal display modes.

Note: When inverting display, Economy symbol in lower right screen will change settings. Simply press "Economy" Key to return to desired setting after inverting display.

Panel Lock: It is possible to lock all of the spaside control keys. Press and hold the Jet 1 key for 5 seconds, "LocP" will appear indicating some of the keys have been locked. To unlock keys, simply press and hold the Jet 1 key for 5 seconds until "ULoc" will appear indicating the spaside has returned to normal operation.

5 Seconds = "LocP" - Partial Lock (Bottom Row Keys Locked)

10 Seconds = "LocF" - Full Lock (All Keys Locked)

Hold 5 seconds to Unlock.

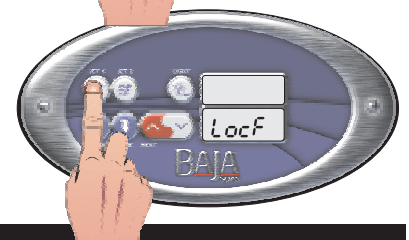

EQUIPMENT FEATURES, CONT'D

HEATER OPERATION: When the water temperature drops 1°F lower than the desired temperature, the heater will be turned on until the water temperature reaches the desired temperature plus 1°F. The Heater On Indicator will appear on the function panel when it is on. The Heater On Light Indicator will blink on the function panel whenever there is a call for heat and the heater has not yet been activated.

FREEZE PROTECTION: When the system senses cold temperatures, it will automatically engage the freeze protection mode for a monitoring period of 24 hours. During this time, the pump will operate for 1 minute every 2 hours to circulate warm water through the plumbing. When the pump is running due to this feature, the Filter Cycle Indicator on the spaside panel will blink. Filter Cycles will operate as determined by the programming and will not be affected by the Freeze Protection Mode.

HIGH TEMPERATURE PROTECTION: If the water temperature exceeds 112°F at the High Temperature probe, the system will display the message HL and will turn the heater off. After the water temperature has cooled down, pressing any key on the spaside panel control will allow the system to restart. If the spa water temperature does not seem to be elevated, the HL reading may have been caused by poor water flow or electrical line interference (e.g. thunderstorms, voltage surges, etc.). Simply reset and monitor the system. See Troubleshooting, page 14. **NOTE: The Freeze Protection Circuit is in effect at all times that there is power applied to the system and will automatically engage if needed.**

DEFAULT SYSTEM OPERATIONS: When power is applied, or there is a temporary loss of power, the system will initiate it's last programmed temperature setting. If a power loss condition is experienced, the spaside display will blink until any key is pressed. This feature is to let the user know that a power failure has occurred.

SETTING FAHRENHEIT AND CELSIUS DEGREES: Press and hold the light key for 5-seconds, the display will change to either setting. When the desired display is shown the display has been set and nothing else must be done.

IN-HOUSE CONTROL PANEL (OPTIONAL)

The In-House Control Panel shares the same functions and has the same features as the spaside control panel located within the spa. It can control the system in conjunction with the control on the spaside, OR AS THE ONLY CONTROL FOR THE SPA. In other words, this control can be the primary or secondary spa control.



The In-House Control Panel can be located up to 300 feet from the spa. It can be conveniently installed inside your house for full access to your spas features. For your convenience and comfort, you can install numerous In-House Control Panels. All remote control panels have complete control of the operation and programming of your spa equipment.

To insure a successful installation, please refer to the In-House Control Panel Installation Guide (85-0343).

EQUIPMENT MODULE

Your Baja Spa is equipped with exclusive "Smart Cords". These cords have internal illumination to let you know that power is being supplied to the components connected to them. This is a helpful troubleshooting feature should a problem with a component arise.



WINTER & SUMMER PROGRAM MODES

Smart Winter Mode: The system is constantly monitoring the temperature with its circuit board mounted sensors. If the sensor registers an ambient temperature below 59°F, the systems “Smart Winter Mode” will activate. This mode, once activated, will continue for a period of 24-hours. The system will activate any pump connected to the system that has not been turned on in the last 2-hours, for 1-minute to prevent freezing. The frequency of this cycle may increase as the ambient temperature drops.

During the “Smart Winter Mode”, the filter cycle icon  will flash while the pump(s) is running in this mode. If the spa is to be drained for an extended period of time, consult your local retailer for winterizing your spa completely due to potentially extreme weather conditions.

If it is desired to keep water in the spa during the time of year when freezing may occur, the heater will operate as required to prevent the water from freezing. In the event of electrical power interruptions, regardless of cause, the heater and pump will stop operating and freeze protection will be lost. **This could result in freeze damage to the spa, spa plumbing and/or Equipment Module components. Such damage is not covered by the Equipment Module Warranty.**

If the spa is to be drained for an extended period of time, consult your local retailer for Winterizing your spa completely due to potentially extreme weather conditions.

Smart Summer Mode: In high heat climates, the spa water temperature may rise above the desired set temperature. If your water temperature rises 4°F above your set temperature, the circulation pump and ozonator will turn off. Your booster pump will turn on high speed for 1 minute twice a day and your circulation pump and ozonator will operate for a minimum of 2 hours. This feature will give you at least 4 hours of filtration per day.

Purge Mode: Twice a day (Factory Default) the booster pump will operate for 1 minute to stir up the spa water to assure 100% water quality maintenance.

WARM WEATHER CONDITIONS

Since your spa will normally be expected to maintain warm to hot water to be ready for your use, a great deal of attention has been directed to the energy conservation detail of insulation so as to keep electrical costs down.

This energy conservation feature may cause an inconvenience during warmer times of the year. During warm periods of the year, the temperature within the equipment compartment can elevate to a point that the pump will automatically turn off for a short period of time (15-30 minutes) to allow the pump to cool down before automatically restarting. This cool down feature will not harm your spa but serves only to protect the pump from damage and as an indicator that it is too hot. To minimize this occurrence, refrain from using your Hydrotherapy Jets for prolonged periods of time during warm seasons.

INSTALLING YOUR PURIFICATION DISPENSER

There are several ways that the water chemistry can be maintained in your Baja Spa. As the photos indicate below, Baja’s built in KLEEN H2O dispenser incorporates the filter lid for either chlorine / bromine tablets or a Nature 2 purification system. The Nature 2 purification system is only recommended for personal use or family spa installations. Chlorine/Bromine or similar is recommended for regular and heavy bather installation. It is very important to maintain proper PH levels between 7.2 - 7.6.



Chlorine/Bromine: Insert Tablets, set and adjust dial. Check every 1-2 weeks.

Nature 2: Insert Cartridge, replace every 4 months.

CAUTION:

ALWAYS CONSULT YOUR DEALER FOR RECOMMENDATION AND MAINTENANCE DETAILS. CONSULT YOUR NATURE2 OWNER’S MANUAL BEFORE INSTALLING PURIFICATION SYSTEM.



JET & FILTER OPERATION

AIR CONTROL



Open air control fittings when in HIGH speed Jets mode to provide air mix to jets. On/Off Toggle.

FILTER REMOVAL

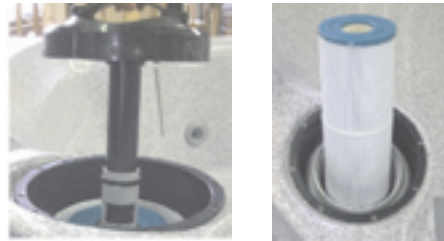

Pull gray tab and turn lock ring counterclockwise. Remove filter lid and cartridge. After cleaning filter, bleed air out of the filter cavity by opening the air relief valve & turn on Circulation Pump.

WATERFALL

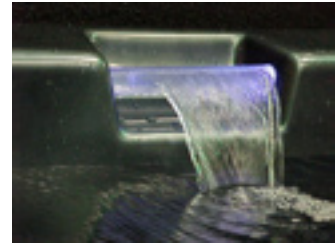

To activate waterfalls, turn dedicated controller clockwise to desired flow. To shut off waterfalls, turn dedicated controller counterclockwise until flow stops.

NIGHTSCAPE LED LIGHTING SYSTEM SHOWS

SLOW COLOR WASH *	Colors transition through the color spectrum. Each color cycle takes approximately 3 minutes.
FAST COLOR WASH *	Colors transition through the color spectrum. Each color cycle takes approximately 1 minute.
SLOW RANDOM COLOR	Colors step from one color to the next in random order. Each color lasts approximately 10 - 15 seconds.
FAST RANDOM COLOR	Colors step from one color to the next in random order. Each color lasts approximately 5 seconds.
HIGH SPEED RANDOM	Rapid series of intense flashes of varying colored light.
CROSS FADE *	Colors cycle back and forth between blue and green. Total cycle lasts 1 minute.
FIXED COLORS	Static display of a single color. Colors include white, pink, lavender, light & dark blue, light & dark green. This is to help you identify the effect.

* These effects begin at a slightly faster speed, then slow down after one or two seconds.

BAJA EXTREME SOUND PRECAUTIONS

These instructions are for spas equipped with the optional Baja Extreme Sound System feature (Optional on the WWXS 1067 & WWXS 1068). "Caution-Risk of electrical shock. Do not leave compartment door open". Replace components only with identical components.

1. **WARNING- Prevent Electrocutation.** Do not connect any auxiliary components (for example speakers, headphones, additional audio/video components etc.) directly to the back of the system. There is one auxilliary input provided at front of unit.
2. These units are not provided with an outdoor antenna. If provided, it should be installed in accordance with Article 810 of the National Electrical Code.
3. Do not service this product yourself, as opening or removing covers may expose you to dangerous voltage or other hazards. Refer all servicing to qualified service personnel.
4. If the power supply connections or power supply cord(s) are damaged, water is entering the audio/video compartment, or any electrical equipment compartment area, the protective shields or barriers are showing signs of deterioration, or there are signs of other potentially hazardous damage to the unit, turn off the unit and contact a qualified service technician.
5. The unit should be subjected to periodic routine maintenance once every quarter to make sure the unit is operating properly.

BAJA BREEZE AROMATHERAPY

Refer to spa scent manufactures recommendations for scent replacement schedule. To install Baja Breeze scents simply:

1. Turn off the booster pump.
2. Unscrew Baja Breeze Aromatherapy cap located on top of spa.
3. Place aromatherapy scents (pack or bag) into canister.
4. Screw cap back onto Baja Breeze Aromatherapy.
5. Turn on booster pump and Turbostream™ jet and open air controller next to Baja Breeze Aromatherapy canister to activate scent.

REGULAR SPA MAINTENANCE

CLEANING THE FILTER:

Your Baja Spa comes complete with a 50 Sq. Ft. (100 Sq. Ft. on Whitewater XS models) filter cartridge that is designed to work under pressure. With normal use, this filter should be removed a minimum of once every 30 days, or anytime you notice an appreciable decrease of the flow from the spa jets. You should take time to clean the filter.

TO CLEAN THE FILTER:

1. TURN OFF THE POWER TO THE EQUIPMENT MODULE OR TURN TEMPERATURE DOWN MORE THAN 4 DEGREES TO TURN OFF CIRCULATION PUMP SYSTEM.
2. REMOVE THE COVER FROM THE FILTER UNIT.
3. OPEN AIR RELIEF PLUG.
4. PULL GRAY TAB AND TURN LOCK RING COUNTERCLOCKWISE (LEFT).
5. REMOVE CARTRIDGE FROM THE FILTER HOUSING AND CLEAN THOROUGHLY WITH PRESSURE SPRAY FROM A NOZZLE ON A GARDEN HOSE.
6. REPLACE THE CLEANED FILTER AND TIGHTEN THE LOCKING RING.
7. TURN ON POWER TO THE EQUIPMENT MODULE.
8. WHEN THE WATER COMES OUT OF THE AIR RELIEF PLUG, CLOSE IT.
9. WHEN WATER IS FULLY FLOWING, SET THERMOSTAT TO DESIRED WATER TEMPERATURE.

It is recommended to completely drain the spa at least four times a year. More frequent draining may be required depending on usage. The spa should also be drained if it is not going to be used for a long period. An empty spa **MUST BE COVERED**. Direct sunlight on the acrylic surface can cause severe damage or blemishing of the surface, and can result in voiding the spa warranty. A cover is supplied with each new spa.

SPA MAINTENANCE SCHEDULE

DAILY	- CHECK WATER LEVEL, REFILL IF NECESSARY TO LINE ON SKIMMER PLATE. - CHECK CHEMICAL READING AND ADJUST AS NEEDED.
WEEKLY	- WIPE DOWN THE WATER LINE. - CHECK WATER FLOW AND CLEAN FILTER IF NECESSARY.
MONTHLY	- CLEAN FILTER CARTRIDGE. - CLEAN THE INSULATED SPA COVER. - TEST THE GFCI.
THREE MONTHS	- DRAIN THE SPA COMPLETELY, REFILL WITH WATER AND REPLENISH CHEMICALS. - WHILE THE SPA IS EMPTY, CLEAN WITH A NONABRASIVE ACRYLIC CLEANER AND RINSE. NOTE: NEVER WAX THE SURFACE AS THE WATER WILL DISSOLVE THE WAX & CLOG THE FILTER.
SIX MONTHS	- CLEAN EON SYNTHETIC CABINET WITH WET TOWEL.

CLEANING THE ACRYLIC SURFACE

When the acrylic surface becomes soiled, it can be cleaned with a soft cloth or sponge. **DO NOT USE ANY ABRASIVE CLEANERS**, as they can scratch or dull the brilliant acrylic surface.

Your insulated cover can be cleaned with a non-abrasive household cleaner. A non-silicone based vinyl restorer will help protect the surface from sun damage.

SPA CABINET INSTRUCTIONS



(PSXS 1044; WWXS 1067/68)
Position corner posts with corner panel under each corner. Attach side panels to corners using panel bolts and bolt driver. Note: Position side panels under spa lip with black kickboard on the bottom.

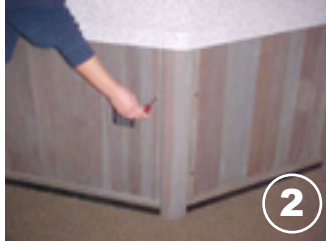

(PSXS 1046) Install corner posts to side panels using panel bolts and bolt driver.

For a PSXS 1042: Install corner posts to end panels (2). Attach side panels to complete.



Completed Baja spa.

CABINET DRAIN VALVE INSTALLATION

INSTALLATION INSTRUCTIONS THRU CABINET DRAIN VALVE BAJA SPA'S EQUIPPED WITH THE THRU CABINET DRAIN VALVE WILL INCLUDE:

- Place cabinet panel with removable 1 ½" black plug in the LEFT CORNER position.
- Black drain valve located to the left of the equipment pack, attached to clear hose with a ¾" hose clamp.

PLEASE FOLLOW THESE INSTALLATION INSTRUCTIONS, PRIOR TO SKIRT ASSEMBLY AND FILLING THE SPA WITH WATER:

- Remove / slide clamp with pliers and take out drain valve from clear hose.
- Discard black cabinet plug and install drain through the hole and secure back nut.
- Place panel in place, making sure there are no crimps in line.
- Secure valve to cabinet.
- Re-attach clear hose completely over barbs and re-secure with clamp.
- Complete cabinet installation.

TO DRAIN SPA- MAKE SURE EQUIPMENT IS IN OFF POSITION

- Remove the drain cap.
- Attach a garden hose to threads.
- Turn front face counter-clockwise and pull outwards.

There should be a slow but steady flow of water which originates from the gravity drain located in bottom of the Baja spa.

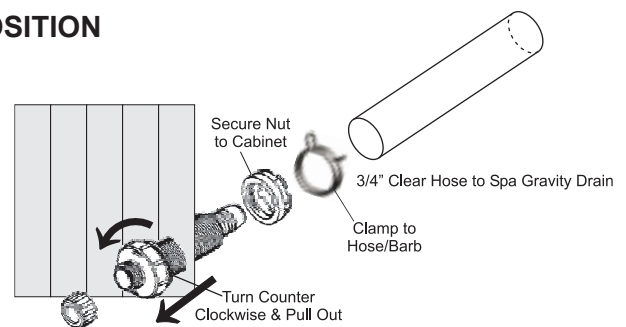

GENERAL TROUBLESHOOTING

The following describes situations and possible solutions to common problems you may encounter as a spa owner.

NOTHING OPERATES	<p>Main Breaker is OFF - Set to On. Sub-Panel Breaker OFF - Set to On. Component(s) not plugged in - Plug in components. Over-Temperature Protection On - Refer to page 9</p>
NO, LOW OR SURGING WATER FLOW	<p>Air Lock in Plumbing System - Refer to "regular spa maintenance," page 12. Restricted Flow - Insure that the water shut-off valves are open and that suction fittings are not blocked by debris. Dirty Filter - Clean or replace filter. Low Water Level - Increase water level to recommended level.</p>
NO JETS OPERATION	<p>Water Shut-Off Valves are Closed - Open Shut-Off valves. Low Level Programming Incorrect - Contact your local dealer. Over-Temperature Protection On - Refer to page 9 Pump Not Plugged-In - Plug in the Pump.</p>
NO CIRCUCLATION PUMP OPERATION	<p>Water Shut-Off Valves are Closed - Open Shut-Off valves. Dirty Filter - Clean or replace filter. Thermal Overload Tripping - Check for restricted flow of water. Over-Temperature Protection On - Refer to page 9 Low Level Programming Incorrect - Contact your local dealer.</p>
NO OZONATOR OPERATION	<p>Ozonator Not Plugged-In - Plug in the Ozonator. Low Water Flow - Clean or Replace filter. Ozone Bulb Defective - Replace bulb or contact your local dealer.</p>
WATER LEAKS	<p>Spa Overfilled - Adjust water level. Too Many People in the Spa - Adjust water level. Drain-Valve Left Open - Close drain valve. Couplings or Unions Loose - Tighten couplings or contact your local dealer. Pump Seal Leaking - Contact your local dealer. Plumbing Connections Leaking - Contact your local dealer. Water Leaking from Spaside Control - Contact your local dealer.</p>
NO HEAT	<p>Temperature Not Set Correctly - Adjust Set Point. Over-Temperature Protection On - Refer to page 9 No Power - Reset breaker at service panel. Low Water Flow - Clean or Replace filter. Pressure Switch Not Adjusted Properly - Contact a qualified technician.</p>
HIGH HEAT	<p>Temperature Sensor Not in Dry-Well - Place sensor in dry-well. Temperature Set Too High - Adjust Set Point. High Ambient Temperature - Remove spa cover.</p>
GFCI TRIPS OCCASIONALLY	<p>Lightning or Electrical Storm, Power Surge, Extremely Humid Conditions, or Radio Frequency Interference - Reset GFCI. NOTE: GFCI must be properly grounded and bonded.</p>
GFCI TRIPS IMMEDIATELY	<p>Defective Component - Contact a qualified service technician for assistance.</p>
NO LIGHT OPERATION	<p>Light Bulb Defective - Replace bulb or contact your local dealer. Light Not Plugged-In - Plug in the Light.</p>
NO POWER TO SPA	<p>Power Switch is OFF - Turn on Power Switch on Equipment Module - Refer to page 9</p>

GENERAL TROUBLESHOOTING, CONT'D

CONTROLLER ERROR INDICATORS

To assist the user in identifying problems with the spa, the system will display an error message. These messages will be helpful when communicating with your local dealer or qualified technician if a problem should arise.

FLE	PRESSURE or FLOW SWITCH ACTIVATED - This error will be displayed only when the pump is not activated. Cycle the circulation pump. If the error does not clear, this is an indication that the pressure or flow switch is activated with no water flow. Contact your local spa dealer
FLO	PRESSURE or FLOW SWITCH NOT ACTIVATED - This error will be displayed while the pump is running. Cycle the circulation pump. If the error does not clear, this is an indication that the pressure or flow switch has not activated although there is water flow. Contact your local spa dealer
Prr	TEMPERATURE SENSOR MALFUNCTION - This error will occur when a problem with the temperature sensor exists. Contact your local spa dealer
OH OR HL	<p>OVERHEAT or HIGH-LIMIT PROTECTION - There are three(3) stages of over-temperature:</p> <p>1 - The spa water has exceeded 112°F at the temperature sensor. The heater, pump and accessory will be deactivated until the water cools to 109°F. Be sure to check the actual water temperature with an accurate thermometer.</p> <p>2 - The spa water has exceeded 119°F at the high-limit sensor. The heater will deactivate while the pump and accessory will still operate. WATER MUST BE BELOW 119°F AND POWER MUST BE RESET TO CLEAR THE "HL" ERROR.</p> <p>A dirty spa filter can also cause a restricted flow of water, be sure the filter is cleaned regularly and ensure all water shutoff valves are open.</p> <p>If the system has been operating normally until now, the pump may be overheating the spa. Refer to "High Temperature Protection" on page 9 and reduce the duration and/or number of cycles per day.</p> <p>3 - If you've eliminated items 1 & 2 as problems, the high-limit sensor may have malfunctioned.</p> <p>Contact your local spa dealer.</p>
FrEE	<p>FREEZE PROTECTION</p> <p>SMART WINTER MODE, this mode will activate any time the temperature falls below 59°F. This mode will be active for a period of 24-hours. In this mode, if a pump has not been activated in the last 2 hours, the system will automatically turn it on for 1-minute to prevent freezing. The "Filter Cycle" indicator will blink while this mode is active.</p>

If the preceding trouble shooting procedure does not correct the problem, then contact your local spa dealer or service technician.

NOTES



hottubs.com

**BAJA PRODUCTS, LTD.
4065 NORTH ROMERO ROAD
TUCSON, AZ 85705**

CUSTOMER SERVICE 800.845.2252 EXT. 310

EMAIL ADDRESS INFO2@BAJASPA.COM

Date _____ Model # _____
Serial Number