



Spa Owner's Manual

FOR

PERFORMANCE XS

and

WHITEWATER XS

NOTE: Important Safety Instructions. Please read and follow all instructions before installing, operating or enjoying your spa. Please refer to the operational video that is supplied with spa.

Save these instructions for future reference.



UNDERWRITER'S
LABORATORIES



HYDROQUIP™



REV08/05

HOTTUBS.COM

DIRECTORY

A BRIEF HISTORY OF SPAS.....	PAGE 2
SAFETY INSTRUCTIONS.....	PAGE 2-4
INSTALLATION GUIDELINES.....	PAGE 5
ELECTRICAL (GENERAL INFORMATION).....	PAGE 6
240 VOLT INSTRUCTIONS.....	PAGE 7
GROUND FAULT CIRCUIT INTERRUPTER.....	PAGE 7
INITIAL START UP.....	PAGE 8
SPA CONTROLLER FUNCTIONS.....	PAGE 9
SPA PROGRAMMING PARAMETERS.....	PAGE 10
FACTORY PRe- SET FILTRATION MODES.....	PAGE 10
SPECIAL FEATURES	PAGE 11
AUXILIARY CONTROL PANEL.....	PAGE 11
NIGHTSCAPE LED LIGHTING SYSTEM.....	PAGE 11
IN-HOUSE CONTROL PANEL.....	PAGE 12
BAJA BREEZE AROMATHERAPY.....	PAGE 12
JET& FILTER OPERATION.....	PAGE 12
WINTERIZING YOUR SPA.....	PAGE 13
SUMMERIZING YOUR SPA.....	PAGE 13
REGULAR SPA MAINTENANCE.....	PAGE 13
INSTALLING YOUR PURIFICATION DISPENSER.....	PAGE 14
TO DRAIN THE SPA.....	PAGE 14
CLEANING THE ACRYLIC SURFACE.....	PAGE 14
SPA MAINTENANCE SCHEDULE.....	PAGE 14
VDS-VISUAL DIAGNOSTIC SYSTEM.....	PAGE 15
TROUBLE SHOOTING VDS.....	PAGE 15
LIGHTED CORD CONNECTION.....	PAGE 15
TROUBLESHOOTING.....	PAGE 16
SPA CABINET INSTRUCTIONS.....	PAGE 17
CABINET DRAIN VALVE.....	PAGE 17
SPA DELIVERY CHECKLIST.....	PAGE 18
SPA SCHEMATIC & NOTES	PAGE 19

A BRIEF HISTORY OF SPAS

The word "spa" is taken from a town in the province of Liege, Belgium where mineral springs were favored for centuries by notables and royalty, including the Russian Czar Peter the Great and German Kaiser William II.

However, the use of mineral springs for therapeutic purposes dates back to the 5th Century B.C., when hot springs in Greece and the Aegean Islands served as healing clinics. At one of these clinics on the Island of Cos, the Greek physician Hippocrates practiced medicine for a while and wrote extensively on hydrotherapy.

The Romans, after a day of conquering the world, retreated to the pleasures of spas. In fact, many well-preserved spas built by the Romans still exist in places as far apart as Bath, England; Baden, Switzerland; and Tiberias, Israel. After the fall of Rome in the 5th Century A.D., the number of spas decreased. It was not until the Renaissance, mysteriously enough, that they once again became numerous. Which raises the question: Does the use of spas result in great thinking, or do great thinkers resort to the use of spas?

A new Baja Spa is the modern machine for today's great thinkers. It blends many advanced features to help you enjoy the benefits of warm water for recreation and therapy.

Baja Products, Ltd. originated the acrylic spa in 1972, and our experience plus dedication assure you of the highest quality components and materials of construction.

We wish you years of enjoyment and relaxation with your new spa. Please take a few minutes to read the safety instructions and operating features described in this manual.

SAFETY INSTRUCTIONS

When installing and using this electrical equipment, basic safety precautions should always be followed, including the following:

1. **READ AND FOLLOW ALL INSTRUCTIONS.**
2. **WARNING** - To reduce the risk of injury, do not permit children to use this product unless they are closely supervised at all times.
3. A wire connector is provided on this unit to connect a minimum No. 8 AWG (8.4 mm²) solid copper conductor between this unit and any metal equipment, metal enclosures of electrical equipment, metal water pipe, or conduit within 5 feet (1.5 m) of the unit.
4. **(For Cord-Connected/Convertible Units)**
DANGER - Risk of injury.
 - a) Replace damaged cord immediately.
 - b) Do not bury cord.
 - c) Connect to a grounded, grounding type receptacle only.

SAFETY INSTRUCTIONS

5. If the supplied cord and plug are not used, the electrical supply for this product must include a suitably rated switch or circuit breaker to open all ungrounded supply conductors to comply with section 422-20 of the National Electrical Code, ANSI/NFPA 70. The disconnecting means must be readily accessible to the spa occupant but installed at least 5 feet (1.5 m) from spa water.
6. **DANGER - Risk of Accidental Drowning.** Extreme caution must be exercised to prevent unauthorized access by children. To avoid accidents, ensure that children cannot use this spa unless they are supervised at all times.
7. **DANGER - Risk of Injury.** The suction fittings in this spa are sized to match the specific water flow created by the pump. Should the need arise to replace the suction fittings or the pump, be sure that the flow rates are compatible.

Never operate spa if the suction fittings are broken or missing. Never replace a suction fitting with one rated less than the flow rate marked on the original suction Fitting.
8. **DANGER - Risk of Electric Shock.** Install at least 5 feet (1.5 m) from all metal surfaces. As an alternative, a spa may be installed within 5 feet of metal surfaces if each metal surface is permanently connected by a minimum No. 8 AWG (8.4 mm²) solid copper conductor to the wire connector on the terminal box that is provided for this purpose.
9. **DANGER - Risk of Electric Shock.** Do not permit any electric appliance, such as a light, telephone, radio, or television, within 5 feet (1.5 m) of a spa.
10. Always enter and exit the spa slowly and cautiously. Wet surfaces can be slippery.
11. Do not use the spa alone.
12. People with infections, skin sores or open wounds should not use the spa.
13. It is recommended that people shower before and after using the spa.
14. Disconnect all electrical power before attempting any kind of service to the electrical module.
15. Always use unbreakable containers around the spa. Never use glass.
16. Never walk, climb, play or jump on the insulated cover of your spa. Never use the spa unless the cover has been completely removed. Do not rely on the cover as a safety cover for children. Children must be supervised when they are in or around the spa.
17. A fence around your spa with a self-closing and self-latching gate can be the best protection against unauthorized use. If your spa is indoors, lock the door to the room to keep out unauthorized users.

SAFETY INSTRUCTIONS

18. Install to provide drainage of compartment with electrical components.
19. **WARNING - To reduce the risk of injury:**
 - a) The water in a spa should never exceed 40°C(104°F). Water temperature between 38°C (100°F) and 40°C(104°F) are considered safe for a healthy adult. Lower water temperatures are recommended for young children and when spa use exceeds 10 minutes.
 - b) Since excessive water temperatures have a high potential for causing fetal damage during the early months of pregnancy, pregnant or possibly pregnant women should limit spa water temperatures to 38°C(100°F).
 - c) Before entering a spa, the user should measure the water temperature with an accurate thermometer since the tolerance of water temperature-regulating devices varies.
 - d) The use of alcohol, drugs, or medication before or during spa use may lead to unconsciousness with the possibility of drowning.
 - e) Persons suffering from obesity or with a medical history of heart disease, low or high blood pressure, circulatory system problems, or diabetes should consult a physician before using a spa.
 - f) Persons using medication should consult a physician before using a spa since some medication may induce drowsiness while other medication may affect heart rate, blood pressure, and circulation.
 - g) Leave the spa immediately if nausea, dizziness or headaches occur immediately cool the body by taking a cool shower or the application of cold towels or ice packs. Seek medical attention if the symptoms persist.
20. Hyperthermia occurs when the internal temperature of the body reaches a level several degrees above the normal body temperature of 98.6 °F. The symptoms of hyperthermia include an increase in the internal temperature of the body, dizziness, lethargy, drowsiness and fainting.

The effects of hyperthermia include
(1) failure to perceive heat, (2) failure to recognize the need to exit spa, (3) unawareness of impending hazard, (4) fetal damage in pregnant women, (5) physical inability to exit spa, (6) unconsciousness resulting in the danger of drowning. **WARNING-** The use of alcohol, drugs, or medication can greatly increase the risk of fatal hyperthermia.
21. Inform all occasional users of these precautions.
22. **SAVE THESE INSTRUCTIONS.**

INSTALLATION GUIDELINES

1. Locate your spa on a solid, level surface that is structurally strong enough to support its filled weight.
2. Installations on wooden decks or balconies should be checked to insure that the floor can support the weight of the full spa and the persons using it.
3. A reinforced poured concrete slab (min. 4" thick) is recommended. However, wood decking is also acceptable, provided it is constructed so that it meets the requirements outlined above.
4. The spa must be installed in such a manner as to provide drainage away from the spa.
5. Spas which will be installed into a floor or wood deck must be installed to permit access to the equipment for servicing.
6. Do not install the spa under any electrical wires.
7. In selecting the ideal outdoor location for your spa, we suggest you take into consideration the following:
 - a) The view you'll have from the spa.
 - b) The proximity to your home for change and/or shelter (this is very important in cold weather).
 - c) A sheltered environment, providing protection from wind and weather if needed.
 - d) The overall enhancement of your yard or room.
 - e) Do not place the spa under a non-guttered roof overhang.
 - f) Indoor installations require provisions for proper ventilation.
 - g) Check local codes for building and fence requirements.
 - h) Water is carried and splashed out by the user, be sure the spa is not located in an area or on a surface that may be damaged by water. (Examples: Carpeting, 2nd floor in house, etc.)
 - i) Indoor spas should be installed in rooms constructed of materials that will not be damaged by high humidity.

General Information

All electrical connections must be accomplished by a qualified electrician in accordance with the National Electrical Code and in accordance with any local codes in effect at the time of installation. All electrical connections must be made in accordance with the wiring information in this manual or on the back of the field wiring access panel of the Equipment Module.

The Equipment Module is designed to operate at 240 volts 60 Hz. When the Equipment Module is connected to 240 volts, the heater will provide approximately 6000 watts of heat when the Circulation pump is operating, the Jet Pump is in HIGH or LOW speed, and the thermostat is calling for heat. Shown on the following page are instructions for connection to a 240 volt electrical service.

Connections must be made using copper conductors only. Field provided GFCI conductors, circuit breakers or fuses must be sized to accommodate the total amperage load of the Equipment Module.

WARNING: Improper electrical connections or conductor sizing may cause the Equipment Module to operate improperly, create the potential for an electrical hazard and may void the warranty.

CAUTION: Use only approved pressure type wire splicing or connectors suitable for the size and type of wiring used.

The electrical supply for the product must include a suitably rated switch or circuit breaker to open all ungrounded supply conductors to comply with Section 422-20 of the National Electrical Code ANSI/NFPA 70. The disconnecting means must be within sight and readily accessible to the user of the spa. It must be installed at least 5 feet (1.4M) from the spa.

Connect a NO. 8 AWG (8.4mm) solid copper bonding conductor between the Equipment Module bonding lug and all other electrical equipment and exposed metal in the vicinity as may be needed to comply with local regulations.

The Electrical supply must also include a suitably rated Ground Fault Circuit Interrupter (GFCI) to comply with Article 680-42 of the National Electrical Code, ANSI/NFPA 70.

A PERMANENTLY CONNECTED SPA is one that is complete with pumps, heater, lighting fixtures and spa side controls.

240 VOLT INSTRUCTIONS

4 WIRE INSTALLATION

(PERMANENTLY CONNECTED UNITS)

The following instructions are for the connection of an Control Module operated at 240 volts / 50 amperes

1. Open the Control Module wiring access panel to allow access to the input terminal block.
2. **PerformanceXS & WhiteWaterXS::** A minimum supply conductor ampacity of 50 amperes and a GFCI circuit breaker size 50 amperes is required.
3. Connect input wiring as shown. The Command Center requires a **4 Wire service (L1, L2, GROUND + NEUTRAL)** 110 volt accessories such as Fiber Optics, BXS Stereo System, Yard Lighting can be added.
4. Close the wiring access panel.

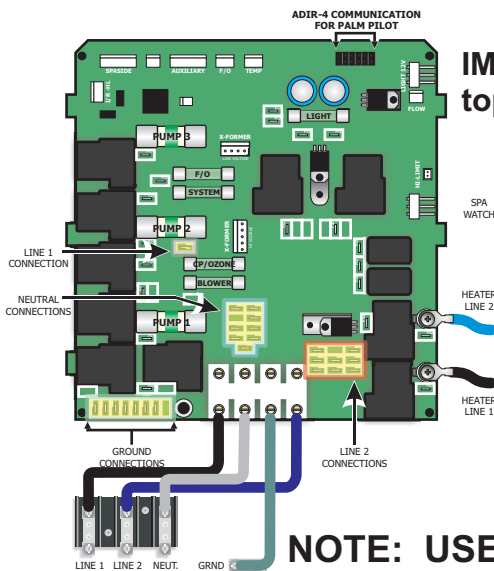

IMPORTANT: Always refer to the product data label (located on top of control box) for specific electrical information.

240-Volt electrical service requires:

Line 1, Line 2, Neutral and Ground.

**240 VOLT WIRING DIAGRAM
(3-Wire Systems Plus Ground)**

**240 Volt
GFCI Circuit Breaker Size - 50AMP**
MINIMUM WIRE SIZE FOR LINE 1, LINE 2,
NEUTRAL = #6 AWG.
MINIMUM WIRE SIZE FOR GROUND = #10 AWG
*Refer to local codes for exact wiring size required

Note:

Have a licensed & qualified electrician perform electrical wiring. Check with local codes and/or National Electrical Code Standards (NEC)

NOTE: USE COPPER CONDUCTORS ONLY!

GROUND FAULT INTERRUPTER

Ground-Fault Circuit-Interrupters and Load Neutral Connection

Most 240 volt panel mounted Ground-Fault Circuit-Interrupter's (GFCI's) are provided with a "LINE" neutral connection lead. Since the GFCI itself is a 120 volt device, this wire must be connected to the neutral buss bar in order for the GFCI to function properly.

Many GFCI's are also provided with a "LOAD" neutral connection terminal. The purpose of the "LOAD" neutral connection terminal is to allow the connection of 120 volt devices to the 240 volt GFCI. If the circuit being connected does not contain any 120 volt devices, the LOAD neutral connection is not used, and the GFCI will provide protection of all 240 volt devices connected. A "LOAD" neutral terminal connection is NOT needed in order for the GFCI to function.

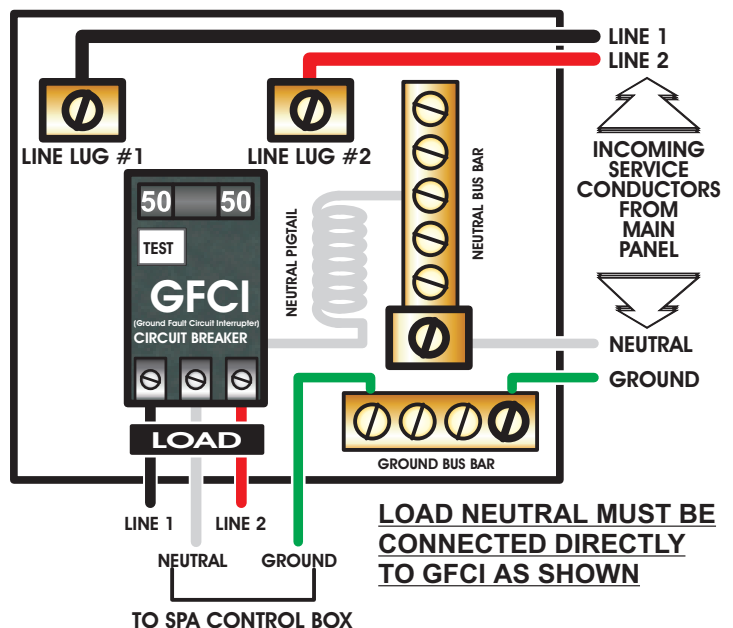

INITIAL STARTUP

WARNING: In order to check for leaks, the following steps are performed without the wood skirting in place. To prevent risk of electric shock, do not use spa at this time.

1. Make sure the power supply is OFF.
2. Check to see that the Black Drain Valve (located to the right side of Equipment Module) is closed.
3. Fill the spa with water to the center line of the skimmer (located inside spa next to headrest).

IMPORTANT NOTE: The Equipment Module must never be operated without water in the spa, serious damage to the heater and/or pump could result.

4. The slide valves on each side of the Equipment Module should be open (the valve is open when the handle is pulled out, closed when it is pushed in).

IMPORTANT NOTE: Valves snap lock into place in "open" and "closed" positions.

5. Check all plumbing connections for water leaks, if any, fix them before proceeding.
6. Before power is applied, refer to and become familiar with the spa side control operations.
7. Apply power to the Equipment Module.
8. Circulation Pump System will come on.

IMPORTANT NOTE: It is very important that the pump be operating for several minutes to assure that all air has been removed from filtration system. The thermostat may only be "turned up" after full water flow has been established.

9. Push the button marked "JET 1". The Booster Pump will now operate at low speed. Press button twice for High speed.
10. Temperature reading will be displayed on digital control. Increase setting to desired temperature.
11. Check for leaks! Although spas are fully checked at factory, shipping & delivery might cause a leak. Call your dealer or Baja directly if there is a problem.

**If your new spa pump does not prime (flow) on the initial start-up...
you may be experiencing an "air lock".**

This normal occurrence can be easily corrected by loosening the plumbing union on the suction side of the pump until water flows into the pump.

Then quickly re-tighten fitting taking care that the O-Ring stays in place.

Turn on the **Low Speed** Pump setting and you should now have normal flow through jets.

Note: OPEN AIR RELIEF VALVE on the filter top when filling spa.

SPA CONTROLLER FUNCTIONS

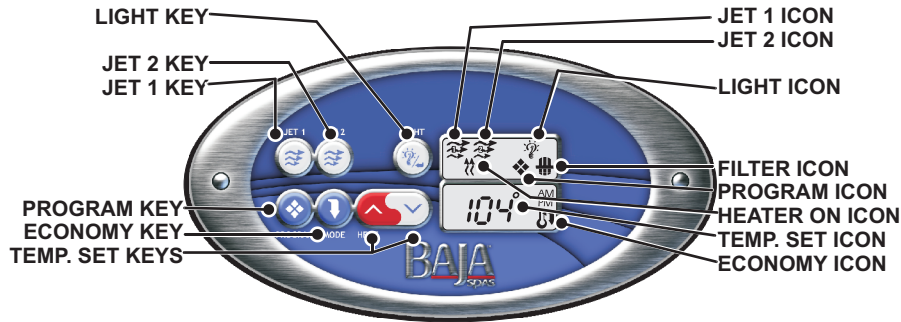

Default System Operation: When power is applied, or there is a temporary loss of power, the system will initiate its default programming.

Jet 1 Key: Press this key once to turn Pump 1 onto Low speed, press this key a second time to turn Pump 1 onto High speed, a third press will turn the pump off. A built-in timer will shut the pump off after 20 minutes of operation unless done so manually. The Pump 1 Icon will appear in the upper LCD window while the pump is running in High speed and flash while it is in Low speed.



Jet 2 Key: Press this key once to turn Pump 2 onto High speed, a second press will turn the pump off. A built-in timer will shut the pump off after 20 minutes of operation unless done so manually. The Pump 2 Icon will appear in the upper LCD window while the pump is running in High speed (WhiteWaterXS™ Only).



Light/Enter Key: Press this key to turn the light on, a second press will turn the light off. The light will automatically shut off after 2 hours. The Light Icon will appear while the light is on. Lights are preprogrammed with an assortment of light shows. Use the spa's light key to turn NIGHTSCAPE on and off. When you turn NIGHTSCAPE off and then on again within five seconds, it advances to the next show. When you turn NIGHTSCAPE off and leave it off for more than five seconds, it "remembers" the last show you selected. The next time you turn NIGHTSCAPE on, it will display the same show. (See page 11 for show schedule)



Temperature Set Keys: Press the Up arrow key to increase the desired temperature. Press the Down arrow key to decrease the temperature. The temperature can be adjusted in 1°F increments from 59°F to 104°F. The new setting will remain on the display for 5 seconds as a confirmation. During this time the Temp. Set icon will appear to let you know this is the desired and not the actual temperature. After 5 seconds, the display will return to the current temperature reading. When the temperature drops to 1°F below the set temperature, the heater will be turned on until the temperature is 1°F above the set temperature. The Heater On icon will appear while the heater is on and flash when there is a call for heat and the heater has not yet been activated.



SPA PROGRAMMING PARAMETERS

Programming Parameters: Follow these procedures to set each parameter: Press and hold the **Program key** for 5-seconds, the program icon will appear. You may continue to press the **Program key** to access the desired parameter to be modified. Once you have reached the parameter to be modified, press the **Enter (Light) key**. Use the Temp. Set keys to adjust the value. If no key has been pressed for 15-seconds, the programming mode is exited automatically. During programming, all keys other than the Program, Enter (Light) and Temp. Set keys will be ignored.

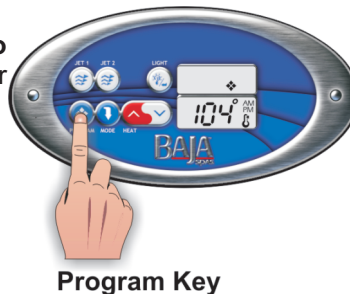

Program Key



Enter Key

Time of Day: (1) This is the first parameter and will automatically appear with the hour flashing. To adjust, **(2)** press the **Enter (Light) key**, use the Temp. Set keys to adjust the hour from 01: to 12: am or pm. **(3)** Press the **Program key** then **Enter (Light) key** to adjust minutes, use the Temp. Set keys to adjust the minutes from :00 to :59. Press the **Program key** to confirm the new setting and wait until controller resets Temperature / Time. Spa will be programmed.

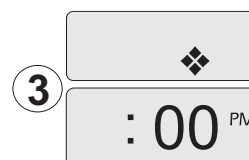
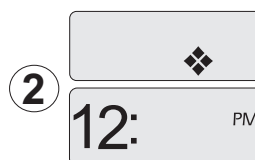
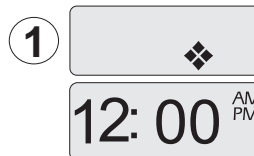

Economy Mode: The Economy mode allows the set point to be reduced by 20°F, without actually changing the set temperature. This mode can be programmed using the Program Key, or it can be overridden by using the Economy Key. Whenever the Economy Key is used, the Economy programming is overridden (forced on or off, toggled each time the key is pressed) until midnight of the current day. At this time, the override is cancelled and standard operation will begin again. When in Economy Mode, the Economy Icon will appear in the display window.



Economy Key

FACTORY PRE-SET FILTRATION MODES

Baja Spas Self Cleaning Spa Filtration Program has been designed to efficiently circulate 24 hours per day. The circulation pump system will only turn off when the spa temperature exceeds 4 (four) degrees above the actual temperature set point.

Baja Spas also added other factory filtration modes and conveniences:

Purge Mode: Everyday at approximately 12:00 Noon, the booster pump will operate for a few minutes to stir up the spa water through the entire system.

Smart Winter Mode: In cold climate areas, Baja Spas are equipped with sensors to detect cold climate situations. These safety sensors will not operate in a power outage. If long outages are expected, it is best to drain and winterize the spa. See Page 13 for winterizing instructions.

Smart Summer Mode: In high heat climate areas, Baja Spas circulation filtration system will automatically perform 2 special filter cycles that run at 10:00AM and 5:00PM respectively for 2 hours each to provide filtration and ozonation.

Economy (EC) - Filtration (FL) Cycles: DO NOT CHANGE THESE FACTORY PRESET MODES!

Should you accidentally go into the programming mode after setting the clock and the spa topside controller reads F1, 2, 3 (Filtration) or E1,2,3 (Economy) **Do Not Change These Factory Preset Modes.**

Simply step away from the spa for 2 minutes and the controls will automatically reset themselves. Changing these modes will alter the factory preset settings.

SPECIAL FEATURES

Inverted Display: Lower display can be inverted for easy viewing inside or outside the spa. Press and hold the Economy key for 2 seconds to toggle between inverted and normal display modes.

Note: When inverting display, Economy symbol in lower right screen will change settings. Simply press "Economy" Key after inverting to return to correct setting prior to using this feature.



Panel Lock: It is possible to lock all of the spaside control keys. Press and hold the Pump 1 key for 5 seconds, "LocP" will appear indicating all the keys have been locked. To unlock keys, simply press and hold the Pump 1 key for 5 seconds until "LocF" will appear indicating the spaside has returned to normal operation.

5 Seconds = "LocP" - Partial Lock

10 Seconds = "LocF" - Full Lock

Hold 5 seconds to Unlock.

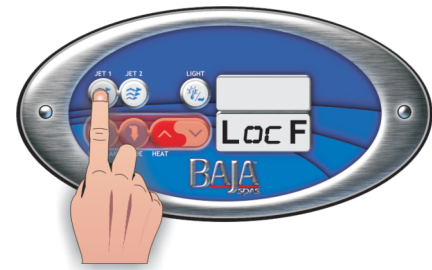

AUXILIARY CONTROL PANEL (WHITEWATER ONLY)



The Auxiliary Control allows you to control up to four basic functions of your spa from a convenient location within your spa.

Each key performs in exactly the same manner as its counterpart on the main keyboard.

Please refer to the User's Manual for your spa's main keypad control for detailed operating information.



JET 1



JET 2



LIGHT

NIGHTSCAPE LED LIGHTING SYSTEM SHOWS

SLOW COLOR WASH *

Colors transition through the color spectrum. Each color cycle takes approximately 3 minutes.

FAST COLOR WASH *

Colors transition through the color spectrum. Each color cycle takes approximately 1 minute.

SLOW RANDOM COLOR

Colors step from one color to the next in random order. Each color lasts approximately 10 - 15 seconds.

FAST RANDOM COLOR

Colors step from one color to the next in random order. Each color lasts approximately 5 seconds.

HIGH SPEED RANDOM

Rapid series of intense flashes of varying colored light.

CROSS FADE *

Colors cycle back and forth between blue and green. Total cycle lasts 1 minute.

FIXED COLORS

Static display of a single color. Colors include white, pink, lavender, light & dark blue, light & dark green.

* These effects begin at a slightly faster speed, then slow down after one or two seconds.

This is to help you identify the effect.

IN-HOUSE CONTROL PANEL (OPTIONAL)



The In-House Control Panel shares the same functions and has the same features as the spaside control panel located within the spa.

The In-House Control Panel can be located up to 300 feet from the spa. It can be conveniently installed inside your house for full access to your spas features.

For your convenience and comfort, you can install numerous In-House Control Panels. All remote control panels have complete control of the operation and programming of your spa equipment.

To insure a successful installation, please refer to the In-House Control Panel Installation Guide (85-0343).

This In-House Control Panel can control the system in conjunction with the control on the spaside, OR AS THE ONLY CONTROL FOR THE SPA. In other words, this control can be the primary or secondary spa control.

BAJA BREEZE AROMATHERAPY

Baja Breeze Aromatherapy restores balance and harmony to all your senses with fresh aromatherapy spa scents. To install Baja Breeze scents simply,

1. Turn off the Booster pump
2. Unscrew Baja Breeze aromatherapy cap located on top of spa
3. Place aromatherapy scents (pack or bag) into canister
4. Screw top back onto Baja Breeze aromatherapy
5. Turn on Booster pump and TurboStream™ jet and open Air Controller next to Baja Breeze Aromatherapy cannister to activate scent

Refer to spa scent manufactures recommendations for scent replacement schedule.

JET & FILTER OPERATION

JET OPERATION:



Open air control fittings when in HIGH speed Jets mode.

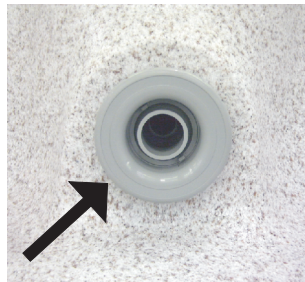

Turn outer ring to direct flow from TurboStream® to Magna Jets. Each TurboStream® jet controls bucket seat jets.

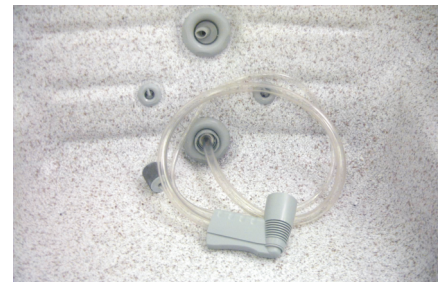

To install (optional) Euro'ssage™, turn Magna Jet counterclockwise and pull straight out then turn Euro'ssage™ slightly clockwise until you feel it click into place.

FILTER REMOVAL:

Note: See Page 13 for cleaning instructions before removing filter.



Pull tab and turn lock ring counterclockwise. Remove filter lid and cartridge. After cleaning filter, bleed air out of the filter cavity by opening the air relief valve & turn on Circulation Pump.

WINTERIZING & SUMMERIZING YOUR SPA

Smart Winter Mode: The system is constantly monitoring the temperature with its circuit board mounted sensors. If the sensor registers an ambient temperature below 59° F, the systems “Smart Winter Mode” will activate. This mode, once activated, will continue for a period of 24-hours. The system will activate any pump connected to the system that has not been turned on in the last 2-hours, for 1-minute to prevent freezing. The frequency of this Cycle may increase as the ambient temperature drops.

During the “Smart Winter Mode” the filter cycle icon  will flash while the pump(s) is running in this mode. If the spa is to be drained for an extended period of time, consult your local retailer for winterizing your spa completely. Due to potentially extreme weather conditions.

If it is desired to keep water in the spa during the time of year when freezing may occur, the heater will operate as Required to prevent the water from freezing.

Smart Summer Mode: During periods of hot weather the water temperature in the spa may rise above the desired or set temperature. As a way to combat this heat rise the control system will go into an automatic “Smart Summer Mode” when the water temperature of the spa raises 4° F over the set water temperature.

This feature will deactivate the circulation pump and ozonation system to help minimize thermal heat transfer until such a time as the actual water temperature falls to the set temperature or the set temperature is manually increased to the present water temperature. The deactivation of the circulation pump and ozonator for long periods of time could have negative effects on water quality, therefore when “Smart Summer Mode” is active the system performs 2 special filter cycles that run at 10:00AM and 5:00PM respectively for 2 hours each to provide filtration and ozonation. ***This function IS NOT user programmable**

REGULAR SPA MAINTENANCE

CLEANING THE FILTER:

Your Baja Spa comes complete with a 50 Sq. Ft. or (100 Sq. Ft. on WhiteWater™ models) filter cartridge that is designed to work under pressure. With normal use, this filter should be removed a minimum of once every 30 days, or anytime you notice an appreciable decrease of the flow from the spa jets. You should take time to clean the filter.

TO CLEAN THE FILTER:

1. TURN OFF THE POWER TO THE EQUIPMENT MODULE OR TURN TEMPERATURE DOWN MORE THAN 4 DEGREES TO TURN OFF CIRCULATION PUMP SYSTEM.
2. REMOVE THE COVER FROM THE FILTER UNIT.
3. OPEN AIR RELIEF PLUG.
4. PULL TAB AND TURN LOCK RING COUNTERCLOCKWISE (LEFT)
5. REMOVE CARTRIDGE FROM THE FILTER HOUSING AND CLEAN THOROUGHLY WITH PRESSURE SPRAY FROM A NOZZLE ON A GARDEN HOSE.
6. REPLACE THE CLEANED FILTER AND TIGHTEN THE LOCKING RING.
7. TURN ON POWER TO THE EQUIPMENT MODULE.
8. WHEN THE WATER COMES OUT OF THE AIR RELIEF PLUG, CLOSE IT.
9. WHEN WATER IS FULLY FLOWING, SET THERMOSTAT TO DESIRED WATER TEMPERATURE.

It is recommended to completely drain the spa at least four times a year. More frequent draining may be required depending on usage. The spa should also be drained if it is not going to be used for a long period.

An empty spa **MUST BE COVERED**. Direct sunlight on the acrylic surface can cause severe damage or blemishing of the surface, and can result in voiding the spa warranty. A cover is supplied with each new spa.

INSTALLING YOUR PURIFICATION DISPENSER

There are several ways that the water chemistry can be maintained in your Baja Spas. As the photo's indicate below, Baja's built in KLEEN H2O dispenser incorporates the filter lid for either chlorine / bromine tablets or Nature 2 purification system. The Nature 2 purification system, is only recommended for personal use or family spa installation. Chlorine/Bromine or similar is recommended for regular and heavy bather installation. It is very important to maintain proper PH levels between 7.2 - 7.6.



Chlorine / Bromine

Insert Tablets, set and adjust dial.
Check every 1-2 weeks

CAUTION:
ALWAYS CONSULT YOUR DEALER FOR RECOMMENDATION AND MAINTENANCE DETAILS.
CONSULT YOUR NATURE2 OWNER'S MANUAL BEFORE INSTALLING PURIFICATION SYSTEM.



Nature 2

Insert Cartridge
Replace every 4 months

TO DRAIN THE SPA

1. Turn off the main circuit breaker or disconnect panel.
2. Attach a garden hose to the drain hose bib and then open hose bib allowing the water to drain from the spa by gravity. For complete draining, place outlet end of hose below bottom of spa (See Page 17).

CLEANING THE ACRYLIC SURFACE

When the acrylic surface becomes soiled, it can be cleaned with a soft cloth or sponge. DO NOT USE ANY ABRASIVE CLEANERS, as they can scratch or dull the brilliant acrylic surface.

Your insulated cover can be cleaned with a non-abrasive household cleaner. A non-silicone based vinyl restorer will help protect the surface from sun damage.

SPA MAINTENANCE SCHEDULE

DAILY - CHECK WATER LEVEL, REFILL IF NECESSARY TO LINE ON SKIMMER PLATE.
- CHECK CHEMICAL READING AND ADJUST AS NEEDED.

WEEKLY - WIPE DOWN THE WATER LINE.
- CHECK WATER FLOW AND CLEAN FILTER IF NECESSARY.

MONTHLY - CLEAN FILTER CARTRIDGE.
- CLEAN THE INSULATED SPA COVER.
- TEST THE GFCI.

THREE MONTHS - DRAIN THE SPA COMPLETELY, REFILL WITH WATER AND REPLENISH CHEMICALS.
- WHILE THE SPA IS EMPTY, CLEAN WITH ANONABRASIVE ACRYLIC CLEANER AND RINSE.
NOTE: NEVER WAX THE SURFACE AS THE WATER WILL DISSOLVE THE WAX AND CLOG THE FILTER.

VDS-VISUAL DIAGNOSTIC SYSTEM

Your system is equipped with Hydro-Quip's exclusive, Visual Diagnostic System, your control will do the troubleshooting for you. VDS consist of control-mounted indicators and (if equipped) HydroQuip Smart Cords. You will know at a glance if a component is being supplied with the proper voltage, if a fuse has blown or (by simply pressing a switch) if the complete system is being supplied with voltage from the breaker panel. The following information will guide you through the Visual Diagnostic System:

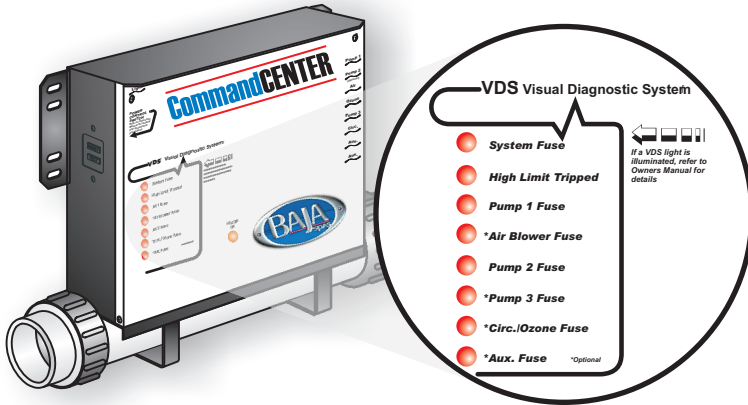

TROUBLESHOOTING VDS

VDS INDICATOR ILLUMINATED	POSSIBLE PROBLEM	VDS INDICATOR ILLUMINATED	POSSIBLE PROBLEM
SYSTEM FUSE - This fuse protects the printed circuit board.	Input voltage connected incorrectly, defective transformer. Call your local dealer.	JET 2 FUSE - Protects the secondary pump.	Restricted flow of water, faulty pump or severe weather or electrical storm. Call your local dealer or qualified technician.
HIGH-LIMIT TRIPPED - Over temperature condition, do not enter spa .	Restricted flow of water caused by dirty filter, water shutoff valve not fully open, improperly adjusted jets, or debris in plumbing. Call your local dealer.	CIRC./OZONE FUSE - Protects a circulation pump and/or ozonator.	Restricted flow of water, faulty pump and/or ozonator or severe weather/electrical storm. Call your local dealer or qualified technician.
JET 1 FUSE - Protects the primary pump.	Restricted flow of water, faulty pump or severe weather/electrical storm. Call your local dealer or qualified technician.	ACCESSORY FUSE -Protects spa fiber optics.	Faulty fiber optic system or severe weather/electrical storm. Call your local dealer or qualified technician.

Your particular system may not include all of the components listed. If a component continually blows the fuse, the component may be defective. Contact your local spa dealer or a qualified technician.

SMART CORD CONNECTION

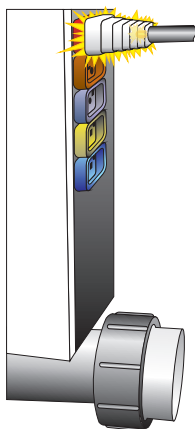

The cords that connect the vital components of your spa to the control have been equipped with internal diagnostic indicators. Whenever a component is operating, that components corresponding plug connection will illuminate to let you know that proper voltage is being supplied.

As a diagnostic tool, if a component is not functioning, a simple glance will tell you if proper voltage is being supplied to that component. If the plug is illuminated but the component is not operating, the component may be defective.

If the plug is not illuminated, the components fuse indicator should be illuminated. If it is not, use the power test switch to ensure that voltage is being supplied to the system.

TROUBLESHOOTING

The following describes situations and possible solutions to common problems you may encounter as a spa owner.

NOTHING OPERATES

Main Breaker is OFF - Set to On.
Sub-Panel Breaker Off - Set to On.
Equipment GFCI Off - Set to On.
Power switch in Off position - Set to On.
Components not plugged in - Plug in components.
Power cord not plugged in - Plug in power cord.
Over or High Temperature Protection On - Refer to "Error Identification".

NO, LOW OR SURGING WATER FLOW

Air Lock in Plumbing System - "Bleed" the system.
Restricted Flow - Insure that the water shut-off valves are open and that suction fittings are not blocked by debris.
Dirty Filter - Clean or replace filter.
Low Water Level - Increase water level to recommended level.

NO THERAPY JET OPERATION

Water Shut-Off Valves are Closed - Open Shut-Off valves.
Dirty Filter - Clean or replace filter.
Jets Not Properly Adjusted - Adjust Jets properly.
Diverter Valve Not Properly Adjusted - Adjust diverter valve properly.
Thermal Overload Tripping - Check for restricted flow of water.
Over or High Temperature Protection On - Turn power to spa on then off to reset.

NO LOW SPEED PUMP OPERATION

Low Level Programming Incorrect - Contact your local dealer.
Over or High Temperature Protection On - Turn power to spa on then off to reset. **Pump Not Plugged-In** - Plug in the Pump.

NO PUMP OPERATION

Pump Not Plugged-In - Plug in the Pump.
Over or High Temperature Protection On - Turn power to spa on then off to reset.

NO HEAT

Set thermostat to a higher temperature setting. Do not expect hot water immediately from the jets. The heater takes several hours to raise the temperature. Check that the suction and return valves are completely open to allow full flow of water through the system. Clean filter if necessary to assure maximum water flow.

NOTE: Heater will not heat properly unless spa is covered when not in use, with a thick insulated spa cover.

WATER DOES NOT CLEAR UP

Check water chemistry for proper chemical balance, and chlorine or bromine residual. Check to insure that filter is clean. IF NOT, CLEAN IT! Water is filtered only while pump is running. If necessary, change to run pump a longer period each day.

SPA READING C° / F°

If spa is reading C° & F° is preferred press and hold "Light" button for 5 seconds to switch

ERROR IDENTIFICATION & SERVICE



If 3 flashing dots appear below the temperature display, an error has occurred and a service call is needed. (Contact Your Local Dealer for Service)



If the actual spa water temperature greatly differs from the displayed temperature or the display reads a constant 33° F, a temperature sensor error and a need for service has occurred. (Contact Your Local Dealer for Service)



If 3 flashing dots below the temperature display and the temperature displayed is 115° or higher, an over temperature condition and a need for service has occurred. (Contact Your Local Dealer for Service)

NOTE: If you notice the pump coming on for seemingly no reason throughout the day, the system may be in "Smart Winter Mode". If you cannot control some functions of the spa, be sure to check to see if the Filtration indicator is illuminated. The spa may be in the midst of a filtration cycle. Freeze Protection and Over temperature condition will also limit or disable spa functions.

POWER SWITCH

Your system incorporates a power switch. This switch will turn power either on or off to the internal circuitry and connected components

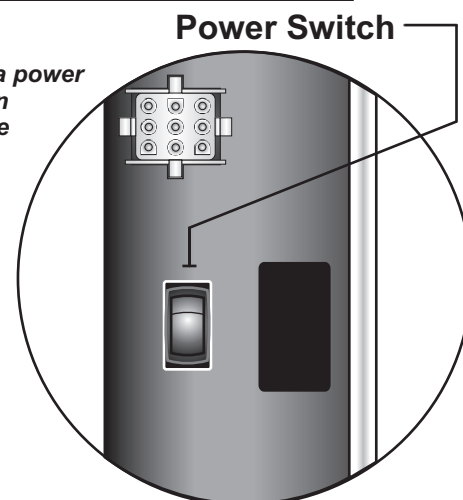

SPA CABINET INSTRUCTIONS



- ① Attach coupling blocks to one end of side panel with toggle bolts and tool supplied with cabinet. (PS 1042, WW 1067/68)



- ② Align with another side panel. Insert bolts and tighten securely.



- ③ Position side panels under spa lip with black kickboard on the bottom.



- ④ Install corner posts (pay attention to "up" arrows) to side panels, then small panels to each corner post around spa using panel bolts and bolt driver.



- ⑤ Completed Baja spa.

CABINET DRAIN VALVE

INSTALLATION INSTRUCTIONS THRU CABINET DRAIN VALVE BAJA SPA'S EQUIPPED WITH THE THRU CABINET DRAIN VALVE WILL INCLUDE:

- Cabinet panel with removable 1 1/2" black plug .
- Place this panel in the LEFT CORNER position on models # 1044/67/68 and in RIGHT SIDE panel position on models # 1042/46.
- Black drain valve located to the right of the equipment pack, attached to clear hose with a 3/4" hose clamp.

PLEASE FOLLOW THESE INSTALLATION INSTRUCTIONS, PRIOR TO SKIRT ASSEMBLY AND FILLING THE SPA WITH WATER:

- Remove / slide clamp with pliers and take out drain valve from clear hose.
- Discard black cabinet plug and install drain thru hole and secure back nut.
- Place panel in place, making sure there are no crimps in line.
- Secure valve to cabinet.
- Re-attach clear hose completely over barbs and re-secure with clamp.
- Complete cabinet installation and fill spa. Following owner's manual instructions.

TO DRAIN SPA- MAKE SURE EQUIPMENT IS IN OFF POSITION

- Remove the drain cap.
- Attach a garden hose to threads.
- Turn front face counter-clockwise and pull outwards.

There should be a slow but steady flow of water which originates from the gravity drain located in bottom of the Baja spa.

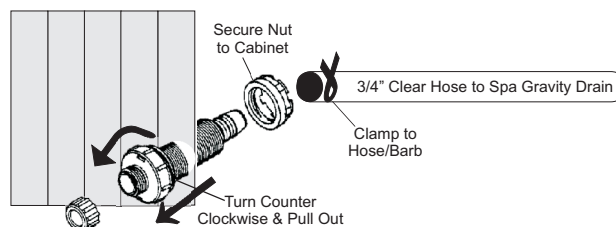



HOTTUBS.COM

Spa Delivery Checklist

Dealer Name _____

Purchaser Information

Name _____

Address _____

Phone (____) _____

Spa Information

Model _____ Serial# _____

Color _____ Equipment serial# _____

Date of Installation _____ Type: w/skirt w/o skirt (circle one)

Color: Sandalwood Gray (circle one)

Voltage potential on delivery _____ Voltage drop _____

Spa Condition	Operational Instruction / Demo	Owners Manuals/ Warranties
Headrest (Condition & Care) _____ _____	____ Time of Day Programming ____ Economy Programming & Effects	____ Spa Owners Manual ____ Spa Owners Operational Video
Spa Cover (Condition & Care) _____ _____	____ Consumer Lifestyle Programming ____ Equipment Function	____ Owners Manual Reviewed w/ Owner
Skirting (Condition & Care) _____ _____	____ Filter Maintenance & Air Relief ____ Chemical Kit & Water Testing	Other _____ _____ _____
Overall Spa Appearance: _____ _____	____ Spa Drain and Function ____ Warranty Information	_____ _____ _____

Optional equipment delivered: _____

Please review the function, use and care of above optional equipment.



hottubs.com

**Baja Products, Ltd.
4065 North Romero Road
Tucson, AZ 85705**

Customer Service.....800-845-2252 Ext. 23

E-Mail Address.....Info@bajaspa.com

Date _____ Model # _____ Serial Number

--	--